



## Catálogo Túnel LED

FLOOD LIGHT LED 100W IP66/IK10  
CODIGO: FL-GL2020-100



### FICHA TÉCNICA

Modelo	FL-GL2020-100	
Poder	100W	
CCT	3000K / 4000K / 5000K / 6000K	
Ángulo de haz	145 * 90 °	
Marca de chip	Bridgelux	
Cantidad de leds	56 piezas	
CRI	≥70	
Eficiencia	155-160lm / w	
Lumen	16000lm	
Tasa IP IK	IP66, IK10	
Tensión de trabajo	AC90-305V 50 / 60Hz	
Temperatura de trabajo	-40 °C ~ 50 °C , 20% ~ 90% HR	
Temperatura de almacenamiento	-40 °C ~ 85 °C 10% ~ 90% HR	
Eficiencia energetica	93%	
PF	> 0,95	
Esperanza de vida	> 50000 horas	
Material de la carcasa	AL6063-T5	
Tamaño ligero	340 * 282,4 * 144,2 mm	± 5 mm
Tamaño del cartón	360 * 410 * 215 mm	± 5 mm
noroeste	4,85 kg	± 0,1 kg



# Catálogo Túnel LED

FLOOD LIGHT LED 100W IP66/IK10

CODIGO: FL-GL2020-100

Dimensiones:

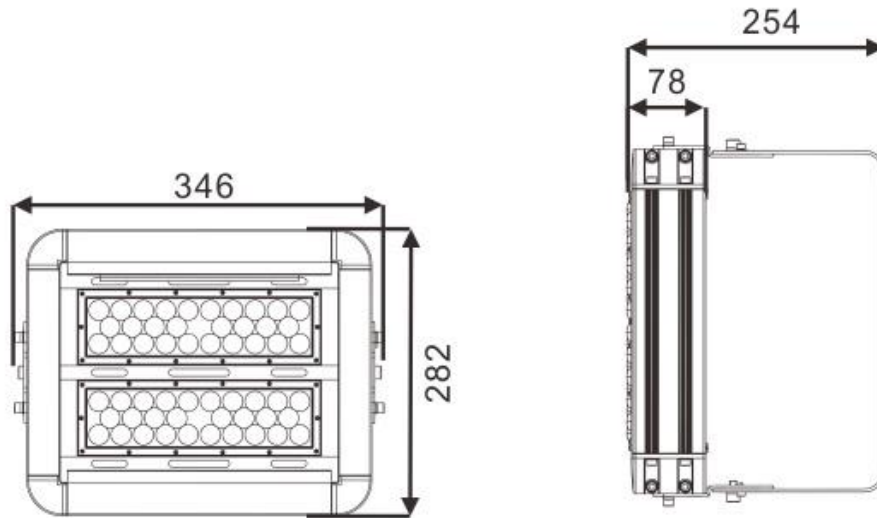

Curva de Distribución:

25°

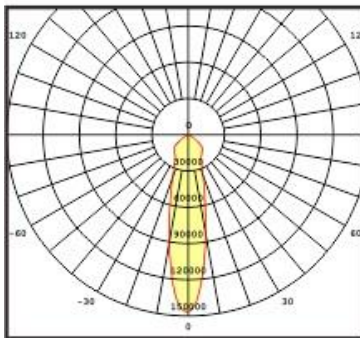

AVERAGE BEAM ANGLE (50%):24.0 DEG

40°

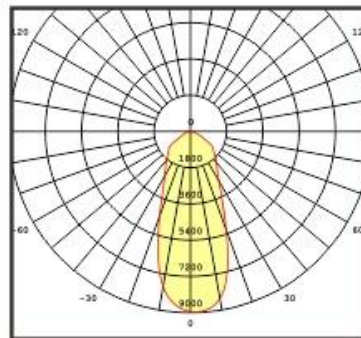

AVERAGE BEAM ANGLE (50%):42.9 DEG

60°

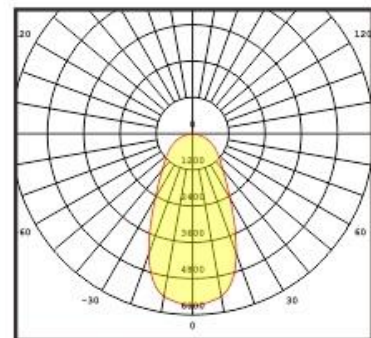

AVERAGE BEAM ANGLE (50%):57.3 DEG

90°

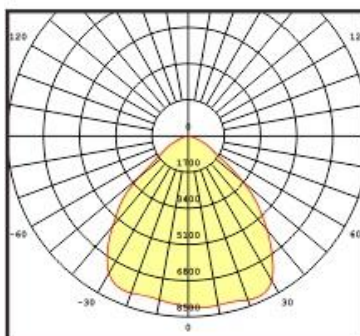

AVERAGE BEAM ANGLE (50%):91.4 DEG

145°X100°

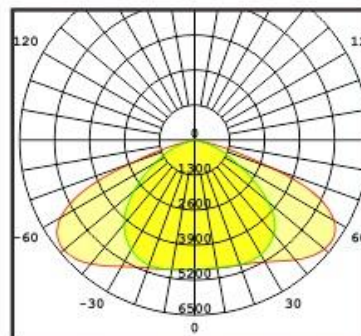

AVERAGE BEAM ANGLE (50%):124.0 DEG

150°

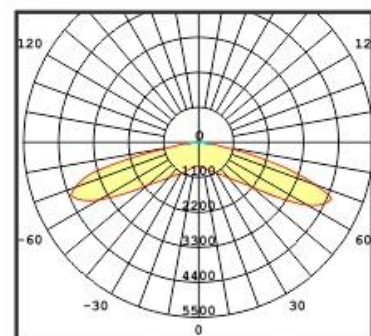

AVERAGE BEAM ANGLE (50%):166.0 DEG